



INSTRUCTION MANUAL

www.bi-comm.co.za

VHF AIR BAND TRANSCEIVER
IC-A210



This device complies with Part 15 of the FCC Rules. Operation is subject to the condition that this device does not cause harmful interference.

Icom Inc.

IMPORTANT

READ ALL INSTRUCTIONS carefully and completely before using the transceiver.

SAVE THIS INSTRUCTION MANUAL — This instruction manual contains important operating instructions for the IC-A210.

EXPLICIT DEFINITIONS

The explicit definitions below apply to this instruction manual.

WORD	DEFINITION
⚠ WARNING	Personal injury, fire hazard or electric shock may occur.
CAUTION	Equipment damage may occur.
NOTE	If disregarded, inconvenience only. No risk of personal injury, fire or electric shock.

Icom, Icom Inc. and the ICOM logo are registered trademarks of Icom Incorporated (Japan) in the United States, the United Kingdom, Germany, France, Spain, Russia and/or other countries.

IBM is a registered trademark of International Business Machines.

Microsoft and Windows are registered trademarks of Microsoft Corporation in the U.S.A. and other countries.

FEATURES

○ **Large, bright OLED display**

A fixed mount VHF airband first! The IC-A210 has an organic light emitting diode (OLED) display. All man-made lighting emits its own light and display offers many advantages in brightness, not brightness, vividness, high contrast, wide viewing angle and response time compared to a conventional display. In addition, the auto dimmer function adjusts the display for optimum brightness at day or night.

○ **Easy channel selection**

It's fast and easy to select any of memory channels in the IC-A210. The "flip-flop" arrow button switches between active and standby channels. The dualwatch function allows you to monitor two channels simultaneously. In addition, the history memory channel stores the last 10 channels used and allows you to recall those channels easily.

○ **GPS memory function**

When connected to an external GPS receiver* equipped with an airport frequency database, the IC-A210 will instantly tune in the local airport frequency as you fly into its airspace.

*Ask your dealer for available GPS receiver details.

○ **13.8 V/27.5 V DC power source**

The built-in DC-DC converter accepts a 13.8/27.5 V DC power source. The IC-A210 is easily installed in most airplanes or vehicles.

○ **Intercom function**

The IC-A210 has a built-in voice activated intercom function allowing the pilot to talk with a co-pilot via headset. The IC-A210 has adjustable audio level and squelch control functions.

PRECAUTIONS

⚠ WARNING! NEVER operate the transceiver with a headset or other audio accessories at high volume levels. Hearing experts advise against continuous high volume operation. If you experience a ringing in your ears, reduce the volume level or discontinue use.

NEVER connect the transceiver to an AC outlet or to a power source of more than 28 V DC. Such a connection will damage the transceiver.

NEVER connect the transceiver to a power source that is DC fused at more than 5 A. Accidental reverse connection will be protected by this fuse, higher fuse values will not give any protection against such accidents and the transceiver will be ruined.

DO NOT operate the transceiver near unshielded electrical blasting caps or in an explosive atmosphere.

DO NOT connect the transceiver to a power source using reverse polarity. This connection will not only blow fuses but also may damage the transceiver.

DO NOT place unit in a non-secure place to avoid inadvertent use by children.

DO NOT push the PTT when not actually desiring to transmit.

DO NOT use or place the transceiver in direct sunlight or in areas with temperatures below -20°C (-4°F) or above $+55^{\circ}\text{C}$ ($+131^{\circ}\text{F}$).

DO NOT place the transceiver in excessively dusty environments.

DO NOT place the transceiver against walls. This will obstruct heat dissipation.

DO NOT use chemical agents such as benzine or alcohol when cleaning, as they damage the transceiver surfaces.

BE CAREFUL! The transceiver will become hot when operating continuously for long periods.

FCC caution: Changes or modifications to this transceiver, not expressly approved by Icom Inc., could void your authority to operate this transceiver under FCC regulations.

TABLE OF CONTENTS

IMPORTANT	i	
EXPLICIT DEFINITIONS.....	i	
FEATURES	i	
PRECAUTIONS.....	ii	
TABLE OF CONTENTS.....	iii	
1 PANEL DESCRIPTION.....	1-4	
■ Front panel	1	
■ Rear panel	3	
■ Main unit.....	3	
■ Function display.....	4	
2 BASIC OPERATION.....	5-8	
■ Frequency selection	5	
■ Standby frequency selection (Step 1-2)	5	
■ Frequency exchanging/not exchanging (Step 2-2).....	6	
■ Receiving.....	6	
■ Transmitting.....	6	
■ Frequency set example	7	
■ Direct frequency setting mode operation.....	8	
■ Dualwatch operation.....	8	
3 MEMORY OPERATION.....	9-18	
■ Programming notes	9	
■ Entering memory mode	9	
■ Memory channel type	9	
■ Channel selection	10	
■ Programming a memory channel	10	
■ Programming example.....	11	
■ Transferring memory contents.....	12	
■ Memory mode menu (Regular memory and group memory channels only)	12	
■ Memory channel	13	
■ Group memory channel.....	13	
■ History memory channel.....	14	
■ Clearing the memory contents (Regular memory and group memory channels only)	14	
■ Programming channel names (Regular memory channel only) ...	15	
■ Programming group names (Group memory channel only)	15	
■ Programming channel tag (Group memory channel only)	16	
■ Channel tag list.....	16	
■ Weather memory channel (U.S.A. version only)	17	
■ GPS memory	17	
■ GPS memory edit	18	
■ Memory protection.....	18	
4 OTHER FUNCTIONS.....	19-21	
■ Lock function	19	
■ Accessing 121.5 MHz emergency frequency	19	
■ Intercom function	20	
■ Squelch test function	20	
■ Weather memory channel scan (U.S.A. version only)	21	
5 MENU MODE.....	22-27	
■ MENU mode programming.....	22	
■ MENU mode items	23	
6 INSTALLATION AND REMOVAL.....	28	
■ Transceiver installation.....	28	
■ Transceiver removal	28	
7 CLONING.....	29	
8 SPECIFICATIONS	30	
9 OPTIONS	31	
10 SAFETY TRAINING INFORMATION	35	

■ Front panel

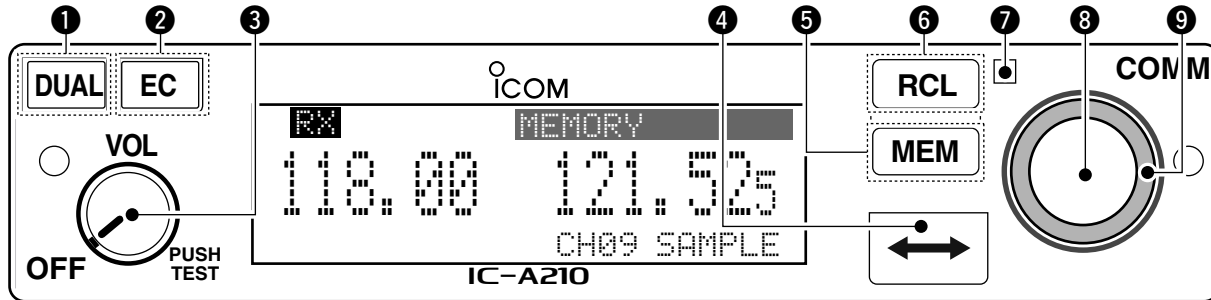

① DUAL SWITCH [DUAL]

- Push to turn dualwatch operation ON or OFF (p. 8).
- Push and hold for 2 sec. to turn the intercom function ON or OFF.

② EMERGENCY CHANNEL SWITCH [EC]

- Push to set the emergency frequency (121.5 MHz) to the standby frequency (p. 19).
- Push and hold for 2 sec. to enter the direct frequency setting mode (p. 8), and set the emergency frequency (121.5 MHz) (p. 19).

③ VOLUME/POWER SWITCH [VOL]

- Turn [VOL] to switch the power ON and OFF (p. 5).
- Adjusts the audio output level.
The volume level bar appears while rotating [VOL].
- Push to set the squelch test function ON or OFF (p. 20).
- Push and hold for 2 sec. to start the weather channel (U.S.A. version only) scan (p. 21).

④ FREQUENCY EXCHANGE SWITCH (FLIP-FLOP)[↔]

- Push to exchange the standby frequency with the active frequency (p. 6).
- Push and hold for 2 sec. to enter direct frequency setting mode (p. 8).

1 PANEL DESCRIPTION

■ Front panel (Continued)

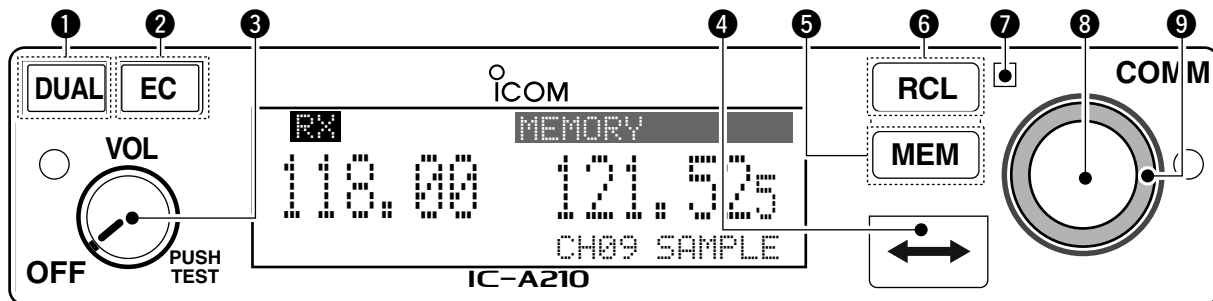

⑤ MEMORY SWITCH [MEM]

- Push and hold for 2 sec. to be programmed a displayed frequency to any blank regular memory channel or delete/revive the selected memory channel (depending on the operating mode) (p. 9).
- Push to display the memory mode menu, and operate selected menu (p. 9).

⑥ RECALL SWITCH [RCL]

- Push to enter/exit the memory mode (p. 9).
- Push and hold for 2 sec. to enter the menu mode (p. 22).

⑦ LIGHT-SENSITIVE DETECTOR

This detector senses ambient light. The detector is used to adjust “Dimmer brightness (Low/High)” (p. 25) automatically when “Dimmer Mode” (p. 25) sets to ‘AUTO.’

⑧ INNER (Small) TUNING DIAL [DIAL]

- Rotate to set the standby frequencies (kHz digit) (p. 5), memory channels (p. 10), MENU mode conditions (p. 22), etc.
- Push and hold for 2 sec. to turn the dial/panel lock function ON (p. 19).

⑨ OUTER (Large) TUNING DIAL [O-DIAL]

- Rotate to set the standby frequencies (MHz digit) (p. 5), group memory channel (p. 13), cursor position (p. 15), etc.
- Rotate to change the scan direction while scanning (p. 21).

■ Rear panel

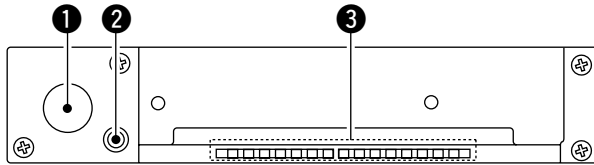

For PS-80 type

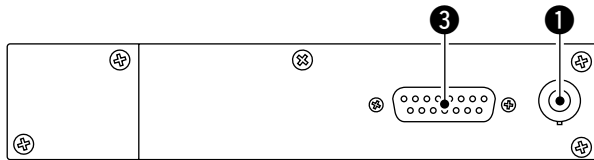

For the 3rd party* compatible type (MB-113)

*Ask your dealer for available products details.

❶ ANTENNA CONNECTOR

Connects an antenna connector.

❷ CLONING JACK

Connects an optional cloning cable (OPC-1529R). Refer to p.29 for details.

❸ DC, MICROPHONE, SPEAKER, HEADPHONE AND DATA JACK

Connects a 13.8 V or 27.5 V DC power supply, speaker, headphone and 3rd party GPS receiver*¹.

Refer to the "INSTALLATION GUIDE" in details.

*¹Ask your dealer for available GPS receiver details.

■ Main unit

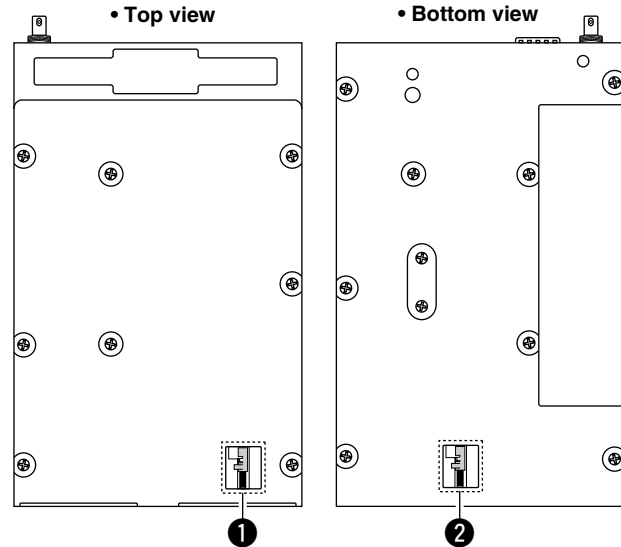

❶ Metal catch (For Icom products)

Use to attach to an installation rack for Icom products (p. 28).

❷ Metal catch (For 3rd party products*)

Use to attach to an installation rack for 3rd party products* (p. 28).

*Ask your dealer for available products details.

1 PANEL DESCRIPTION

■ Function display

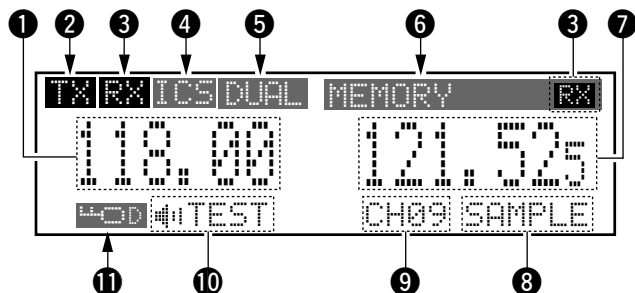

1 ACTIVE FREQUENCY INDICATOR

- Shows the active frequency (p. 6).
- Shows the MENU mode items in the MENU mode (p. 22).

2 TX INDICATOR

Appears while transmitting (p. 6).

3 RX INDICATOR

- Appears when receiving a signal on the active frequency signal (p. 6).
- Appears when receiving a signal on the standby frequency signal while dualwatch operation (p. 8).
- Appears when opening the active frequency's squelch function (p. 6).

4 INTERCOM INDICATOR

Appears when the intercom function is in use (p. 20).

5 DUALWATCH INDICATOR

Appears when the dualwatch function is active (p. 8).

6 MEMORY CONDITION INDICATOR

- Indicates "MEMORY" when the regular memory channel is selected (p. 13).
- Indicates "GRP01-GRP20" when the group memory channel is selected (p. 13).
The group name is also indicated if the name has been entered.
- Indicates "HISTORY" when the history memory channel is selected (p. 14).
- Indicates "WEATHER" when the weather memory channel is selected (U.S.A. version only) (p. 17).
- Indicates "GPS" when the GPS memory channel is selected (The 3rd party GPS receiver is required) (p. 17).

7 STANDBY FREQUENCY INDICATOR

- Shows the standby frequency (p. 5).
- Shows the setting values in the MENU mode (p. 22).

8 CHANNEL NAME INDICATOR

Shows the channel name during memory mode (p. 15).

9 MEMORY CHANNEL INDICATOR

Shows the selected memory channel number during memory mode (p. 13).

10 TEST INDICATOR

Appears while the squelch test function is active (p. 20).

11 LOCK INDICATOR (p. 19)

- Indicates "LOCK" while the dial lock function is in use.
- Indicates "PL" while the panel lock function is in use.

■ Frequency selection

IC-A210 has 2 ways to select a desired frequency.

◇ General frequency selection

Select a desired frequency which is used for the next operating frequency in the standby frequency indicator. Then exchange the active frequency for the standby frequency.

NOTE: Operate from “Standby frequency selection (Step 1-2)” to “Frequency exchanging (Step 2-2)” as pgs. 5–6.

◇ Direct frequency selection

A desired frequency direct selection is available.
Refer to “Direct frequency selection mode operation.”

TIP: For quick frequency setting, often used frequencies can be programmed into memory channels. Refer to “MEMORY OPERATION” (pgs. 9–18).
When a memory channel is recalled, the previous standby frequency is erased.

■ Standby frequency selection (Step 1-2)

CAUTION:

DO NOT turn the power ON until the aircraft engines have been started. It is very important for protection of the power supply circuit.

- ① Rotate **[VOL]** clockwise to turn power ON.
 - Previously used frequencies appear in the active and standby frequency indicators.
- ② Rotate **[DIAL]** and **[O-DIAL]** to select a desired frequency to the standby frequency.
 - The active frequency is not affected.
 - Rotate **[O-DIAL]** to set above 1 MHz digit.
 - Rotate **[DIAL]** to set below 100 kHz digit.
 - Set the frequency step* in the menu mode, if necessary (p. 27).
*Available for depending on versions.

2 BASIC OPERATION

■ Frequency exchanging/ not exchanging (Step 2-2)

- ① After selecting the standby frequency, push [↔] to exchange the standby frequency with the active frequency.

NOTE: DO NOT push and hold [↔] continuously. Otherwise the standby frequency disappears. If this happens, again push and hold [↔] until the standby frequency reappears.

- Rotate [VOL] to set the volume level, if necessary.
 - When receiving a signal, “RX” appears and audio is emitted from the speaker or headset.
 - Further adjustment of audio level may be necessary at this point.
 - Adjust the squelch level in the menu mode, if necessary (p. 24).
- ② Push and hold [PTT] to transmit, then speak into the microphone.
 - Transmit indicator “TX” lights.
 - ③ Release [PTT] to receive.

Frequency exchanging can be also performed remotely from the yoke-mounted frequency exchange switch.

TIP: The intercom function is useful for swift communication between the pilot and co-pilot.

Set the communication/intercom switch on the VHF control panel to the “intercom” position. Voice signals from the microphone are sent to both the pilot and co-pilot’s headsets.

■ Receiving

- ① Select an operating frequency.
 - Refer to pgs. 5–6 in details.
 - “RX” appears when receiving a signal or opening squelch.
- ② Push [VOL] to open the squelch manually.
 - Refer to p. 20 “Squelch test function” in details.
- ③ Rotate the volume control to adjust the audio level.

■ Transmitting

NOTE: To prevent interference, listen on the frequency before transmitting. If the frequency is busy, wait until the frequency is clear.

- ① Select the yoke-mounted communication/intercom switch to the “communication” position.
- ② Select an operating frequency.
 - Refer to pgs. 5–6 in details.
- ③ Push the PTT switch.
 - “TX” appears.
- ④ Speak into the microphone at your normal voice level.
 - **DO NOT** set the microphone too closely to your mouth or speak too loudly. This may distort the signal.
- ⑤ Release the PTT switch to receive.

Frequency set example

The following example shows to how to select 126.40 MHz in the standby frequency indicator and then exchange it to the active frequency indicator.

① Rotate [O-DIAL] clockwise to select "126" MHz.



Previously used frequencies appear.

② Rotate [DIAL] counterclockwise to select "400" kHz.

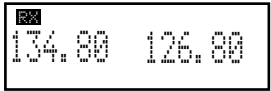

Rotate the large tuning dial to change the standby frequency in MHz steps.



Rotate the small tuning dial to change the standby frequency in kHz steps.

③ Push [↔].

DO NOT push and hold. See "Direct frequency setting mode operation" on p. 8 if you make a mistake and do push and hold.



The active frequency and the standby frequencies are exchanged.

2 BASIC OPERATION

■ Direct frequency setting mode operation

The direct frequency setting mode operation is useful when setting a desired frequency directly to the active frequency indicator.

- ① Push and hold [**↔**] for 2 sec. to enter the direct frequency setting mode.
 - The only active frequency is displayed.

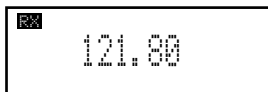

- ② Select an operating frequency.
 - Refer to pgs. 5–6 in details.
- ③ Push [**RCL**] or [**↔**] to exit the direct frequency setting mode.

■ Dualwatch operation

The dualwatch operation monitors active and standby frequencies alternately. Therefore, it's useful to monitor the standby frequency while receiving the active frequency.

- ① Push [**DUAL**] to enter dualwatch operation.
 - "DUAL" appears on the active frequency indicator.
 - The active or standby frequency's "RX" blinks when receiving signal or opening the squelch.

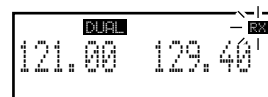

- ② Push [**DUAL**] again to exit dualwatch operation.
 - "DUAL" disappears.
 - You may also exit dualwatch by pushing [**PTT**].

ATTENTION!

During dualwatch operation, the standby frequency's AF may be interrupted at constant intervals, but this is not a malfunction.

■ Programming notes

◇ Blank channel

A memory or group channel with no frequency content is called as a blank channel. When a blank channel is selected while memory programming, “———” appears instead of a frequency.

◇ Memory protect function

IC-A210 has a memory protect function. The function prevents accidental changes or deletion. The function can be set in the MENU mode.

■ Entering memory mode

- Push [RCL] to enter the memory mode.
- Push [RCL] to set the selected memory channel frequency to the standby frequency, then exit the memory mode.
- Push and hold [RCL] for 2 sec. to exit the memory mode (The standby frequency is set the frequency before entering the memory mode).

■ Memory channel type

The transceiver has 5-memory* channel types as follows.

*Depends on versions, the transceiver has 5 different types of memory channels.

◇ Regular memory channel (MEMORY)

There are up to 10 available memory channels.

The following functions are available:

REPLACE, DELETE, REVIVE and CHANNEL NAME EDIT functions.

◇ Group memory channel (GRP01–GRP20)

There are up to 200 group channels (10 CH × 20 Groups).

The following functions are available:

REPLACE, DELETE, REVIVE, GROUP NAME EDIT and CHANNEL TAG functions.

◇ Weather memory channel (WEATHER) (U.S.A. version ONLY)

10 weather memory channels are available.

They are used for monitoring NOAA (National Oceanic and Atmospheric Administration) broadcasts (reception of weather memory channels possible in U.S.A. version only).

◇ History memory channel (HISTORY)

There are up to 10 available history memory channels.

The active frequency is written into history memory channels automatically when pushing [↔] to exchange the active and standby frequency (except weather channels: U.S.A. version only).

◇ GPS memory channel (GPS)

There are up to 10 available GPS memory channels.

When connected to an external GPS receiver* equipped with an airport frequency database, the frequency data such as nearby airports can be transferred into GPS memory channels .

* Ask your dealer for available GPS receiver details.

3 MEMORY OPERATION

■ Channel selection

The transceiver has 10 regular memory and 200 group channels (10 channels × 1 REGULAR MEMORY and 10 channels × 20 GROUPS) for storage of often-used frequencies along with 6-character notes.

- ① Push **[RCL]** to enter the memory mode.
 - The channel number appears.
 - The memory channel name also appears if it has been entered.
- ② Rotate **[O-DIAL]** to select the memory channel type.
 - Select from regular memory channel or group memory channel.
- ③ Rotate **[DIAL]** to select a desired memory channel number.



Transferring the memory channel to the active frequency is necessary if operating at the memory channel.

Refer to “Transferring memory contents” (p. 12) for details.

- ④ Push **[RCL]** to exit the memory mode.

■ Programming a memory channel

This transceiver is equipped with 10 regular memory and 200 group channels. You can program often-used frequencies into them.

- ① Rotate **[DIAL]** and **[O-DIAL]** to set a desired frequency for the standby frequency indicator.
- ② Push **[RCL]** to enter the memory mode.
 - The channel number appears.
 - The memory channel name also appears if it has been entered.
- ③ Rotate **[O-DIAL]** to select a desired memory channel type.
 - Select regular memory channel or group memory channel.
- ④ Push **[MEM]**, and then rotate **[O-DIAL]** to select a “REPLACE” menu.
 - The memory channel number blinks.
- ⑤ Rotate **[DIAL]** to select a memory channel to be programmed.
- ⑥ Push **[MEM]**, then the selected memory channel is programmed.
 - “WRITE COMPLETED” appears on the display when the regular memory channel is programmed.
- ⑦ Push **[RCL]** to exit the memory mode.

■ Programming example

The following is an example showing how to program 126.000 MHz into regular memory channel 4.

- ① Set a “126.000 MHz” in the standby indicator.

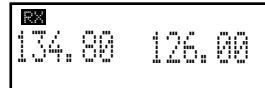

“126.00” appears in the standby indicator.

- ② Push [RCL], then rotate [O-DIAL] to select “MEMORY”.



“MEMORY” and regular memory channel number appear.

- ③ Select regular memory channel 4 with [DIAL].



“.....” appears when no frequency has been programmed into regular memory channel 4.

- ④ Push [MEM], then rotate [O-DIAL] to select “REPLACE.”



Regular memory channel number blinks.

- ⑤ Push [MEM] to store the desired frequency into the selected regular memory channel.



“WRITE COMPLETED” is displayed when the selected frequency is stored.

TIP: Push and hold [MEM] for 2 sec. to program a displayed frequency to any blanket memory channel automatically, after step

①.

NOTE: The programming is cancelled while all regular memory channels have already programmed.

3 MEMORY OPERATION

■ Transferring memory contents

This function transfers a memory channel's contents into the active frequency indicator.

- ① Push **[RCL]** to enter the memory mode.
 - The channel number appears.
 - The memory channel name also appears if it has been entered.
- ② Rotate **[O-DIAL]** to select a desired memory channel type.
 - Select regular, group history, weather* or GPS memory channel.
 - * Selectable depending on versions.
- ③ Rotate **[DIAL]** to select a memory channel to be transferred.
- ④ Push **[↔]**, then the selected memory channel is transferred into the active frequency indicator.
 - The memory mode is cancelled automatically.



Push **[↔]**.

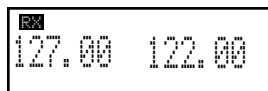

■ Memory mode menu (Regular and group memory channels only)

◇ REPLACE

Replacing the selected memory channel to the standby frequency.

◇ DELETE

Deleting the selected memory channel.

◇ REVIVE

Returning the selected memory channel to its previous state.

◇ CH NAME (Regular memory channel only)

Setting the channel name to the selected regular memory channel.

◇ GRP NAME (Group memory channel only)

Setting the group name to the selected memory group.

◇ CH TAG (Group memory channel only)

Setting the channel tag to the selected memory channel (Selecting the group memory channel is the only option).

◇ DONE

Return to the memory mode.

■ Regular memory channel

The transceiver has 10 regular memory channels. 5 actions are selectable.

- ① Push **[RCL]** to enter the memory mode.
 - The channel number appears.
 - The memory channel name also appears if it has been entered.
- ② Rotate **[O-DIAL]** to select the regular memory channel.
 - “MEMORY” appears.



- ③ Rotate **[DIAL]** to select a desired channel.
- ④ Push **[MEM]**, then rotate **[O-DIAL]** to select a menu as follows.
 - The memory channel number blinks.

REPLACE	Replace to the standby frequency.
DELETE	Delete the memory channel.
REVIVE	Revive the previous memory channel data.
CH NAME	Edit the memory channel name.
DONE	Do nothing and return to the memory mode.

- ⑤ Push **[MEM]** to perform the selected action.

■ Group memory channel

The transceiver has 200 memory channels 200 group channels (10 channels × 20 groups). 6 actions are selectable.

- ① Push **[RCL]** to enter the memory mode.
 - The channel number appears.
 - The memory channel name also appears if it has been entered.
- ② Rotate **[O-DIAL]** to select the group memory channel.
 - “GRP01–GRP20” appears.



- ③ Push **[DIAL]**, and then rotate **[O-DIAL]** to select the memory group from GRP01 to GRP20 if necessary.
 - The group and channel numbers blink.
 - Push **[DIAL]** again, or push **[RCL]** to set the memory group.
- ④ Rotate **[DIAL]** to select a desired channel.
- ⑤ Push **[MEM]**, rotate **[O-DIAL]** to select a menu as follows.
 - The memory channel number blinks.

REPLACE	Replace to the standby frequency.
DELETE	Delete the memory channel.
REVIVE	Revive the previous memory channel data.
GRP NAME	Edit the group name.
CH TAG	Set the memory channel as a tag channel.
DONE	Do nothing and return to the memory mode.

- ⑥ Push **[MEM]** to perform the selected action.

3 MEMORY OPERATION

■ History memory channel

The transceiver has 10 history memory channels.

The standby frequency is stored into a history memory channel when pushing [↔].

The frequency is stored into the history memory channel in order from “CH01” to “CH10.”

- ① Push **[RCL]** to enter the memory mode.
 - The channel number appears.
 - The memory channel name also appears if it has been entered.
- ② Rotate **[O-DIAL]** to select the history memory channel.
 - “HISTORY” appears.



- ③ Rotate **[DIAL]** to select a desired channel.
 - Push [↔] to exchange the history memory channel frequency to the active frequency if necessary.
- ④ Push **[RCL]** to exit the memory mode.

■ Clearing the memory contents (Regular and group memory channels only)

Unwanted memory channels can be cleared.

- ① Push **[RCL]** to select memory mode.
 - The channel number appears.
 - The memory channel name also appears if it has been entered.
- ② Rotate **[O-DIAL]** to select the memory channel type.
 - Select from regular memory channel or group memory channel.
- ③ Rotate **[DIAL]** to select a desired channel.
- ④ Push **[MEM]**, then rotate **[O-DIAL]** to select “DELETE.”
 - The memory channel number blinks.



- ⑤ Push **[MEM]** to delete the memory channel data.
 - “- - - - -” appears momentarily, then the next selectable channel appears.



- ⑥ Push **[RCL]** to exit the memory mode.

NOTE: Instead of steps ④ and ⑤, pushing and holding **[MEM]** for 1 sec. after step ③ also allows delete or revive operation.

■ Programming channel names (Regular memory channel only)

The regular memory channel can display a 6-character name in addition to the memory number.

- ① Push **[RCL]**, then rotate **[O-DIAL]** to select a desired regular memory channel in the memory mode.
 - Rotate **[O-DIAL]** to select the memory channel type if necessary.
- ② Rotate **[DIAL]** to select a desired channel.
- ③ Push **[MEM]**, then rotate **[O-DIAL]** to select “CH NAME.”
- ④ Push **[MEM]**, then memory channel name’s 1st digit blinks.
- ⑤ Rotate **[DIAL]** to select a desired character.
 - The character type as shown below is selectable.
 - Push **[DIAL]** to switch capital (A, B, C, ...) → lower case (a, b, c, ...) → number (0, 1, 2, ...) → capital (A, B, C, ...) in order.
- ⑥ Rotate **[O-DIAL]** to select the next input digit.
- ⑦ Repeat ⑤–⑥ to input the memory channel name.
- ⑧ Push **[MEM]** to decide the memory channel name.

• Selectable characters

0 1 2 3 4 5 6 7 8 9 : ; < = > ? @
A B C D E F G H I J K L M N O P Q R S T U V W X Y Z [\] ^ _ `
a b c d e f g h i j k l m n o p q r s t u v w x y z { } ~ ■ ! " # \$ % & ' () * + , - . /

■ Programming group names (Group memory channel only)

The group memory channel can display a 6-character name in addition to the group number (“GRP01”–“GRP20”).

- ① Push **[RCL]**, then rotate **[O-DIAL]** to select a desired memory channel in the memory mode.
 - Rotate **[O-DIAL]** to select the memory channel type if necessary.
- ② Push **[DIAL]**, and then rotate **[O-DIAL]** to select the memory group from GRP01 to GRP20, if necessary.
 - Push **[DIAL]** again to decide the memory group.
- ③ Push **[MEM]**, then rotate **[O-DIAL]** to select “GRP NAME”.
- ④ Push **[MEM]**, then group name’s 1st digit blinks.
- ⑤ Rotate **[DIAL]** to select a desired character.
 - The character type as shown left “Selectable characters” is selectable.
 - Push **[DIAL]** to switch capital (A, B, C, ...) → lower case (a, b, c, ...) → number (0, 1, 2, ...) → capital (A, B, C, ...) in order.
- ⑥ Rotate **[O-DIAL]** to select the next input digit.
- ⑦ Repeat ⑤–⑥ to input the group name.
- ⑧ Push **[MEM]** to decide the group name.

3 MEMORY OPERATION

■ Programming channel tag (Group memory channel only)

The tag name can be set a 3-character name in addition to the group number. It is convenient for separating memory type.

- ① Push **[RCL]**, then rotate **[O-DIAL]** to select a desired group memory channel in the memory mode.
 - Rotate **[O-DIAL]** to select the memory channel type if necessary.
- ② Push **[MEM]**, then rotate **[O-DIAL]** to select “CH TAG” when selecting “LABEL” in “Group memory channel display” of the menu mode (p. 24)
- ③ Push **[MEM]**, then rotate **[DIAL]** to select a desired channel tag.



- The tag type as shown below is selectable.

- ④ Push **[MEM]** to decide the channel tag.

• Selectable tags

___ / TWR / GND / ATS / ATF / APP / ARR / AWS / CLR / CTF / DEP / FSS / RFS / UNI / MF / OTH / U-1 / U-2

■ Channel tag list

TAG NAME	DISPLAY		MEANS
	Group*1	GPS*2	
---	YES	–	Non-tag
TWR	YES	YES	Tower
GND	YES	YES	Ground
ATS	YES	YES	ATIS
ATF	YES	YES	Air traffic
APP	YES	YES	Approach
ARR	YES	YES	Arrival
AWS	YES	YES	Automatic Weather Station
CLR	YES	YES	Clearance / Delivery
CTF	YES	YES	Common Traffic Advisory Frequency
DEP	YES	YES	Departure Frequency
FSS	YES	YES	Flight Service Station
RFS	YES	YES	Remote Flight Service Station
UNI	YES	YES	Unicom frequency
MF	YES	YES	Mandatory frequency
OTH	YES	–	Other
U-1	YES	–	User1 setting (Refer to p. 26)
U-2	YES	–	User2 setting (Refer to p. 26)

*1Group memory, *2GPS memory

Weather memory channel (U.S.A. version only)

The U.S.A. version has VHF marine WX (weather) channel receiving capability for flight planning.

- ① Push **[RCL]** to enter the memory mode.
 - The channel number appears.
- ② Rotate **[O-DIAL]** to select the weather memory channel.
 - “WEATHER” appears.
- ③ Rotate **[DIAL]** to select a desired channel.
- ④ Push **[RCL]** to exit the weather memory mode.



Weather memory channel list

Channel	Frequency	Channel	Frequency
WX01	162.550 MHz	WX06	162.500 MHz
WX02	162.400 MHz	WX07	162.525 MHz
WX03	162.475 MHz	WX08	161.650 MHz
WX04	162.425 MHz	WX09	161.775 MHz
WX05	162.450 MHz	WX10	163.275 MHz

GPS memory

When connected to an external GPS receiver* equipped with an airport frequency database, frequency data such as nearby airports can be transferred and made available in the GPS memory (maximum 10-memory channels).

*Ask your dealer for available GPS receiver details.

NOTE: See the GPS receiver’s instruction manual when transferring the frequency data in details.

- ① Push **[RCL]** to enter the memory mode.
 - The channel number appears.
- ② Rotate **[O-DIAL]** to select the GPS memory channel.
 - “GPS” appears.
- ③ Rotate **[DIAL]** to select a desired channel.
- ④ Push **[RCL]** to exit the GPS memory mode.

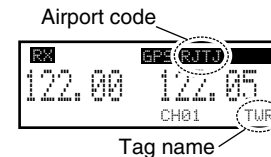

3 MEMORY OPERATION

■ GPS memory edit

The received GPS memory data is stored to desired group memory channel.

NOTE:The GPS memory data is overwritten if the setting group memory channel has already memorized other data.

- ① Push **[RCL]** to enter the memory mode.
 - The channel number appears.
 - The memory channel name also appears if it has been entered.
- ② Rotate **[O-DIAL]** to select the GPS memory channel.
 - “GPS” appears.
- ③ Push **[MEM]** to enter the GPS memory channel edit mode, then rotate **[O-DIAL]** to select a desired group memory.
 - “GPS” and airport code blink.
- ④ Push **[MEM]** to store the GPS memory channel data to the selected group memory.
- ⑤ Push **[RCL]** to exit the memory mode.

■ Memory protection

The transceiver has memory protection which inhibits to the editing (storing, deleting, replacing, etc.) of the memory group memory channels.

Refer to “Memory Protection” (p. 24) for details.

■ Lock function

The lock function prevents accidental frequency changes and accidental function activation.

- ① Push and hold **[DIAL]** for 2 sec. to turn the lock function ON.
 - “**L-D**” appears when DIAL lock mode is selected.
 - “**L-P**” appears when PANEL lock mode is selected.
- ② To turn the function OFF, repeat step ① above.
 - “**L-D**” or “**L-P**” disappears.

NOTE: AUTOMATIC LOCK RELEASE FUNCTION

This transceiver has an “Automatic Lock Release Function” which releases the Lock function automatically when an operator gets into a panic.

The function performs when operating to push any keys (except **[EC]**) 8-times or rotating any dials (except **[VOL]**) 25-clicks for 5 sec.

■ Accessing 121.5 MHz emergency frequency

The IC-A210 can be set to the 121.5 MHz emergency frequency quickly. This function can be activated even when the key lock function is in use.

- ① Push **[EC]** to call the emergency frequency to the standby frequency, and then entering the dualwatch operation automatically.
- ② Push **[↔]** to transfer emergency frequency to the active frequency if necessary.
 - “**EC**” appears.
- ③ Push **[↔]** to exit from the emergency frequency.
 - Set the frequency except 121.500 MHz before pushing **[↔]** to the standby frequency if necessary.
 - “**EC**” disappears.

/// **NOTE:** “**EC**” also appears on the display while the active frequency is set to 121.500 MHz.

CONVENIENT!: Push and hold **[EC]** for 2 sec. to enter the direct frequency setting mode (p. 8), and set the emergency frequency (121.5 MHz).

- “**EC**” appears.

4 OTHER FUNCTIONS

■ Intercom function

When 2-headphone and microphone jacks are connected to the transceiver, these headsets can be used as a voice-activated intercom.

- ① Enter to the MENU mode.
 - See p.22 for details.
- ② Set Intercom Usable Setting to ON.
 - See p.27 for details.
- ③ Exit from the MENU mode.
 - See p.22 for details.
- ④ Push and hold **[DUAL]** for 2 sec. to enable the intercom function.
 - “ICS” appears.

- The headphone audio output level can be selected “OFF,” “output level fixing (001–080)” or “interlocking with [VOL]” in the MENU mode (p. 23).
- The microphone1 and microphone2 audio input levels can be also selected “OFF” or “output level fixing (001–080)” in the MENU mode (p. 23).

■ Squelch test function

This function opens the squelch manually for testing.

- ① Push **[VOL]** to turn the squelch test function ON.
 - “TEST” appears.
- ② To turn the function OFF, repeat step ① as above.
 - “TEST” disappears.

■ Weather memory channel scan (U.S.A. version only)

Scanning searches for weather channel signals automatically and makes it easier to listen purposes.

Repeatedly scans all weather memory channels.

This function is available for the U.S.A. version only.

- ① Set to the weather memory channel mode.
- ② Push and hold **[VOL]** for 2 sec. to start weather memory channel scan.
 - To change the scan direction, turn **[DIAL]**.
 - “NO WTH” appears when no signal receives from WX01– WX10 channels. Then the weather memory channel scan stops automatically.
 - “SEARCH” flashes while scanning.
- ③ Push and hold **[VOL]** for 2 sec. again to stop the scan.



■ MENU mode programming

MENU mode is available at power ON and allows you to set seldom-changed settings. In this way you can customize transceiver operations to suit your preferences and operating style.

◇ Operating MENU mode

- ① Rotate [VOL] to turn the transceiver's power ON.
- ② Push [RCL] to set VFO mode if memory mode is selected.
- ③ Push and hold [RCL] for 2 sec. to enter the MENU mode.
- ④ Rotate [O-DIAL] to select setting items.
- ⑤ Rotate [DIAL] to select a desired condition.
- ⑥ Push [RCL] to exit MENU mode, and returning to the previous operating condition.

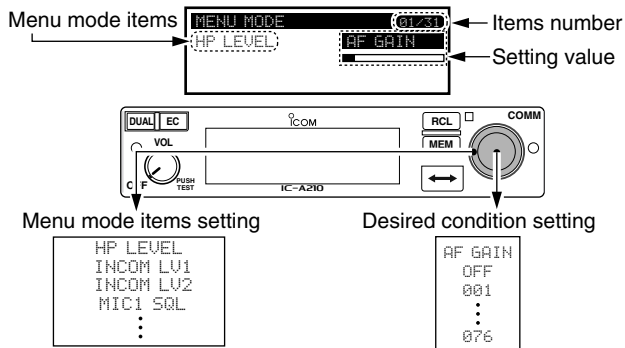

• MENU mode items

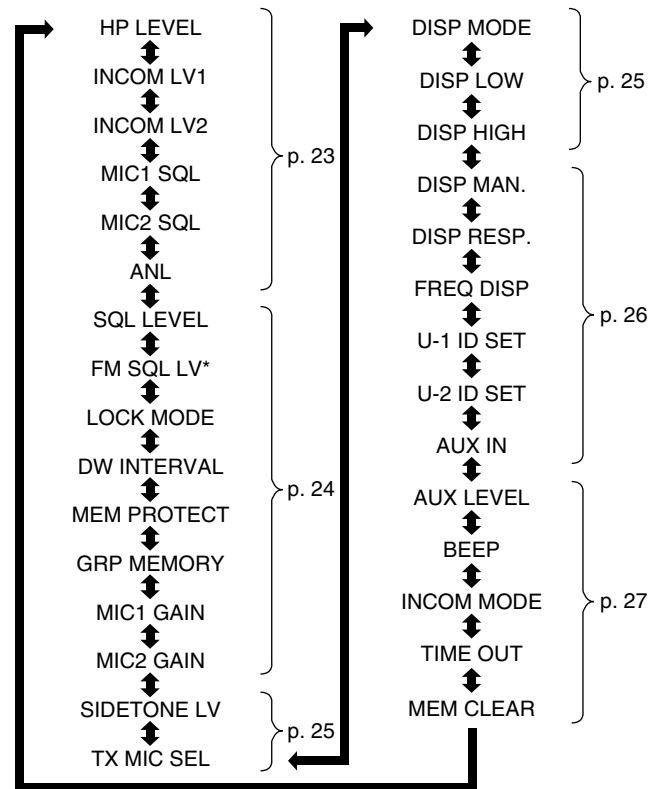

*Not available on all versions.

■ MENU mode items

◇ Headphone Level “HP LEVEL”

Set the headphone output level while receiving.

- AF gain : The output level is same as [VOL].
- OFF (0) : While muting the headphone.
- 001–080 : Setting audio level from 1 to 80.

◇ Intercom1 Microphone Audio Input Level “INCOM LV1”

Set the intercom1 microphone input level.

- OFF (0) : While muting the intercom1 microphone.
- 001–080 : Setting the intercom1 input level from 1 to 80.

◇ Intercom2 Microphone Audio Input Level “INCOM LV2”

Set the intercom2 microphone input level.

- OFF (0) : While muting the intercom2 microphone.
- 001–080 : Setting the intercom2 input level from 1 to 80.

◇ Intercom1 Squelch Level “MIC1 SQL”

Set the intercom1 squelch level.

The setting level is required to open the squelch when speaking to the intercom1.

- OFF (0) : While opening the intercom1 squelch.
- 001–030 : Setting the intercom1 squelch level from 1 to 30.

◇ Intercom2 Squelch Level “MIC2 SQL”

Set the intercom2 squelch level.

The setting level is required to open the squelch when speaking to the intercom2.

- OFF (0) : While opening the intercom2 squelch.
- 001–030 : Setting the intercom2 squelch level from 1 to 30.

◇ Automatic Noise Limiter “ANL”

The ANL (Automatic Noise Limiter) function reduces noise components such as that caused by engine ignition systems while receiving.

- OFF : The ANL function is OFF.
- ON : The ANL function is ON.

5 MENU MODE

■ MENU mode items (Continued)

◇ **AM Squelch Level** “SQL LEVEL”

Set the squelch level for AM mode operation.

In order to receive signals properly, as well as for the scan to function effectively, the squelch must be adjusted to the proper level.

- -010-010 : Setting AM squelch level from -10 to 10.

◇ **FM Squelch Level** “FM SQL LV” (U.S.A. version only)

Set the squelch level for FM mode operation.

- -010-010 : Setting FM squelch level from -10 to 10.

◇ **Lock Mode** “LOCK MODE”

Set the lock function effective area.

- OFF : The lock function is nonfunctional.
- DIAL : The lock function applies to [DIAL].
- PANEL : The lock function applies to buttons on the front panel.

◇ **Dualwatch Interval** “DW INTERVAL”

Set the interval time while operating dualwatch or weather scan.

- FAST : The interval time sets to 300 msec.
- MID : The interval time sets to 600 msec.
- SLOW : The interval time sets to 2 sec.

◇ **Memory Protection** “MEM PROTECT”

Set the memory protection to regular memory channels and group memory channels.

Editing the regular memory and group memory channels is inhibited while the protection is ON.

- OFF : The memory protection is OFF.
- ON : The memory protection is ON.

◇ **Group Memory Channel Display** “GRP MEMORY”

Set the displaying whether the label displays or not.

- CH : The only channel number is displayed.
- LABEL : The label is also displayed.

◇ **Microphone1 Gain** “MIC1 GAIN”

Set the microphone1's gain.

- -010-010 : Setting the microphone1's gain from -10 to 10.

◇ **Microphone2 Gain** “MIC2 GAIN”

Set the microphone2's gain.

- -010-010 : Setting the microphone2's gain from -10 to 10.

■ MENU mode items (Continued)

◇ Sidetone Level “SIDETONE LV”

When using an optional headset (supplied from 3rd party*) via the adapter, the transceiver outputs your transmitted voice to the headset for monitoring.

*Ask your dealer in details.

- OFF (0) : The sidetone function is OFF.
- 001–080 : Setting sidetone level from 1 to 80.

◇ Transmitting Microphone Selection “TX MIC SEL”

Set the usable microphone when pushing microphone’s PTT switch.

The item allows you to control which connected microphone is permitted to transmit.

- MIC1 : Selecting the microphone1.
- MIC2 : Selecting the microphone2.
- MIC1+2 : Selecting both the microphone1 and microphone2.

◇ Dimmer Mode “DISP MODE”

Set the OLED dimmer mode.

- OFF : The dimmer function is OFF.
- AUTO : Set the dimmer automatically depending on local brightness.
The light sensor which built-in the display is used for this function.
- MANUAL : Set the dimmer depending on Dimmer Brightness (Low) “DISP LOW”.

◇ Dimmer Brightness (Low) “DISP LOW”

Set the lower brightness level in the automatic adjustment range when “AUTO” is selected at the “Dimmer Mode.”

The transceiver automatically adjusts its display brightness by the current lighting conditions.

- OFF : The key backlight sets OFF.
- 001–049 : Setting low dimmer brightness level from 1 to 49.

◇ Dimmer Brightness (High) “DISP HIGH”

Set the upper brightness level in the automatic adjustment range when “AUTO” is selected at the Dimmer Mode.

- 050–100 : Setting dimmer brightness level from 50 to 100.

5 MENU MODE

■ MENU mode items (Continued)

◇ **Dimmer Brightness (Manually)** “DISP MAN.”

Set the brightness manually to suit your own preferences.

- 0–100 : Setting dimmer level manually from 0 (OFF) to 100.

◇ **Dimmer Response** “DISP RESP.”

Set the dimmer switching speed when selecting “AUTO” at the “Dimmer Mode.”

- STANDARD

: Selecting switch speed is normal.

- FAST

: Selecting switch speed is fast.

◇ **Frequency Display** “FREQ DISP”

Set the 1 kHz digit frequency displaying to the OLED.

- OFF : The 1 kHz digit always does not display on the OLED.
- ON : The 1 kHz digit always display on the OLED.
- ZERO SUPP.

: The 1 kHz digit display on the OLED (Except the digit is 0).

◇ **USER-1 Setting** “U-1 ID SET”

Set the USER-1, channel tag, to a desired ID.

- ① Push **[MEM]** to enter the U-1 ID edit mode.
- ② Rotate **[DIAL]** to select a desired character.
- ③ Rotate **[O-DIAL]** to select the next input digit.
- ④ Repeat ②–③ to input the U-1 ID.
- ⑤ Push **[MEM]** again to store the U-1 ID, and exit the edit mode.

◇ **USER-2 Setting** “U-2 ID SET”

Set the USER-2, channel tag, to a desired ID.

- ① Push **[MEM]** to enter the U-2 ID edit mode.
- ② Rotate **[DIAL]** to select a desired character.
- ③ Rotate **[O-DIAL]** to select the next input digit.
- ④ Repeat ②–③ to input the U-2 ID.
- ⑤ Push **[MEM]** again to store the U-2 ID, and exit the edit mode.

◇ **External Input** “AUX IN”

Set the external input mode.

- OFF : The external input does not use.
- ON : The external input is available while squelch is closing.
- INCOM : The external input is available with the intercom operations as following.
 - The intercom function is OFF.
 - While the intercom function does not use.
 - While audio signal does not input to the intercom’s microphone.

■ MENU mode items (Continued)

◇ External Input Level “AUX LEVEL”

Set the external input level.

- OFF (0) : The external input does not operate.
- 001–080 : Setting the external input level from 1 to 80.
- AF GAIN : Interlocking with [VOL].

◇ Beep Tone Level “BEEP”

Confirmation beep tones normally sound when storing memory, operating time-out-timer function, etc. These can be set a desired beep level as you prefer.

- OFF (0) : The beep tone turns OFF.
- 001–100 : Setting the beep tone level from 1 to 100.

NOTE:

When using an external speaker, the beep tone level when the squelch is closed is fixed and cannot be changed in the MENU mode.

◇ Intercom Usable Setting “INCOM MODE”

Set the intercom using or not.

- ON : The intercom is usable.
- OFF : The intercom is unusable.

◇ Time-Out-Timer “TIME OUT”

To prevent accidental prolonged transmission, etc., the transceiver has a time-out-timer function. This timer starts when a transmission begins, and will cut off the transmission when the time set in the timer elapses.

- 020–240 : Setting time-out-timer starting period from 20 sec. to 240 sec. at 10 sec. intervals.

◇ Memory Clear “MEM CLEAR”

Setting values in the CPU are cleared.

Push and hold **[MEM]** for 2 sec., the CPU is reset as follow.

- MENU : MENU mode items are reset.
- MEMORY : Stored memories are reset.
- ALL : All CPU data is reset.

■ Transceiver installation

- ① Insert a $\frac{3}{32}$ in allen wrench into the 2-holes in the front panel.

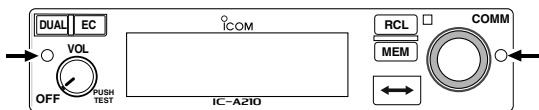

- ② Turn the wrench counterclockwise until the front panel is loose.
- A cable connects the front panel with the main unit.
- ③ Disconnect the flat cable from the front panel's connector to remove the front panel.

• Front panel rear view

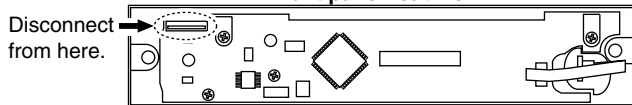

NOTE: Treat the flat cable with care when disconnecting it.

- ④ Visually confirm that the metal catches on the top and bottom of the transceiver are as shown below.

• Main unit top/bottom view

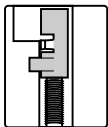

- ⑤ Turn the wrench clockwise until the main unit is fixed to the installation rack.
- Turn the wrench in the upper socket as shown below when using the installation rack for Icom products.
 - Turn the wrench when in the lower socket as shown below when using the installation rack for 3rd party* products.

• Main unit front view

Use for pre-existing Icom radio installations

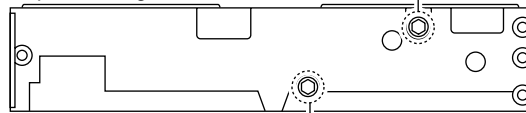

Use for pre-existing 3rd party radio* installations
*Ask your dealer for available products details.

- ⑥ Replace the disconnected cable and removed front panel in place.

NOTE: Treat the flat cable with care when disconnecting it.

■ Transceiver removal

The IC-A210 may easily be removed from the installation rack, if desired.

- ① Perform the same steps as ①–③ of “Transceiver installation” to remove the front panel (See the left column).
- ② Turn the wrench counterclockwise until the main unit moves slightly from the installation rack.
- See ⑤ of “Transceiver installation” for details.
- ③ Pull out the transceiver slowly from the installation rack.

◇ Data cloning

Cloning allows you to quickly and easily transfer the programmed contents or data from a PC to a transceiver using the optional CS-A210 CLONING SOFTWARE.

Data can be cloned to and from a PC (IBM compatible) using the optional CS-A210 CLONING SOFTWARE and the optional OPC-1529R CLONING CABLE (connect with the data jack). Consult the CS-A210 instruction manual and HELP file for details.

◇ Displayed Message

- While clone writing.

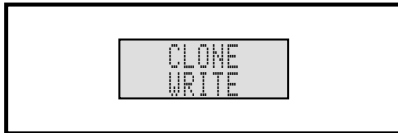

- When clone writing is finished properly.

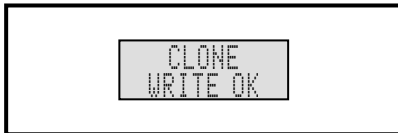

- When clone writing error occurs.

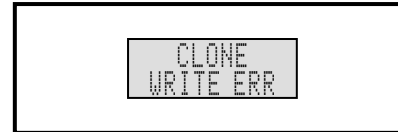

- While clone reading.

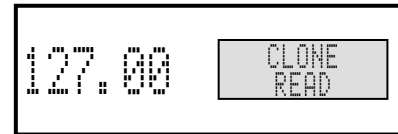

- When turn the power OFF/ON after clone writing error occurs.

(The transceiver boots with Error mode.)

In this case, Clone writing correctly data to the transceiver is necessary to cancel the error.

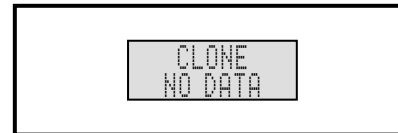

◇ **General**

- Frequency range : 118.000 to 136.975 MHz
161.650 to 163.275 MHz*
- Channel spacing : 25 kHz
- Frequency stability : ±5 ppm
- Operating temperature : -20°C to +55°C
-4°F to +131°F
- Antenna impedance : 50 Ω
- Number of memory channels : 10 memory channels
200 group channels
10 history channels
10 GPS channels
10 weather channels*
- Mode : AM (6K00A3E)
- Power supply requirement : 13.80 V / 27.50 V DC
(negative ground)
- Dimensions : 160 (W)×34 (H)×271 (D) mm
(projections not incl.) $6^{5/16}(W) \times 1^{11/32}(H) \times 10^{21/32}(D)$ in
- Weight : approx 1.0 kg; 2.2 lb

*U.S.A. version only, receiving only.

◇ **Transmitter**

- Mode : A3E
- Output power : 8 W (Carrier power)
- Spurious emissions : -60 dBc
- Microphone impedance : 600 Ω
- Modulation limiting : 70% (Max 98%)

◇ **Receiver**

- Receive system : Double conversion
superheterodyne
- Intermediate frequencies : 1st 38.85 MHz
2nd 450 kHz
- Sensitivity : (AM) Less than 2 μV (pd)
at 6 dB S/N
(FM) Less than 1.4 μV
at 12 dB SINAD*
- Selectivity : 6 dB ±3 kHz
60 dB ±22 kHz
- Spurious response rejct. : More than 74 dBμ
- Audio output power : 5 W with a 4 Ω load (External
speaker)
60 mW with a 500 Ω load
(Headphone)

Measurements made in accordance with RTCA DO-186B for U.S.A. version. All stated specifications are subject to change without notice or obligation.

◇ **CS-A210** CLONING SOFTWARE

Provides quick and easy programming of items, including private channels, scan settings, etc., via an Windows® PC (Microsoft® Windows® 2000/Me/XP/Vista™) to transceiver.

◇ **OPC-1529R** CLONING CABLE

This cloning cable provides convenient connection to a PC to access programmable features, such as memory channels, memory name, etc.

◇ **MB-53** MOUNTING BRACKET

For mounting the transceiver to a vehicle. The external speaker and microphone are included.



◇ **PS-80** POWER SUPPLY

Provides convenient operation of the transceiver on the ground. A built-in speaker and microphone* are included.

*Depending on version.

NOTE: PS-80's specifications

- Dimensions : 200 (W) × 200 (H) × 300 (D) mm
7.9 (W) × 7.9 (H) × 11.8 (D) in
- Outputs : 13.8 V DC / 6 A



INDEX

A	
Accessing 121.5 MHz emergency frequency	19
AM squelch level	24
Automatic noise limiter	23
B	
Basic operation	5
Beep tone level	27
Blank channel	9
C	
Channel selection	10
Channel tag list	16
Clearing the memory contents	14
Cloning	29
D	
Data cloning	29
Dimmer brightness (High)	25
Dimmer brightness (Low)	25
Dimmer brightness (Manually)	26
Dimmer mode	25
Dimmer response	26
Direct frequency selection	5
Direct frequency setting mode operation	8
Displayed message	29
Dualwatch interval	24
Dualwatch operation	8
E	
Emergency frequency	19
Entering memory mode	9
External input	26
External input level	27
F	
FM squelch level	24
Frequency display	26
Frequency exchanging/not exchanging	6
Frequency selection	5
Frequency set example	7
Frequency step	27
Front panel	1
Function display	4
G	
General frequency selection	5
GPS memory	17
GPS memory channel	9
GPS memory edit	18
Group memory channel	9, 13
Group memory channel display	24
H	
Headphone level	23
History memory channel	9, 14
I	
Installation and removal	28
Intercom function	20
Intercom usable setting	27
Intercom1 Microphone audio input level	23
Intercom1 squelch level	23
Intercom2 Microphone audio input level	23
Intercom2 squelch level	23
L	
Lock function	19
Lock mode	24
M	
Memory channel type	9
Memory clear	27
Memory mode menu	12

Memory operation9
 Memory protect function.....9
 Memory protection18, 24
 Menu mode items.....23
 Menu mode programming.....22
 Microphone1 gain24
 Microphone2 gain24

O

Operating menu mode22
 Other functions.....19

P

Panel descriptions.....1
 Programming channel names15
 Programming channel tag.....16
 Programming example11
 Programming group names.....15
 Programming notes.....9
 Programming a memory channel.....10

R

Regular memory channel9, 13

S

Safety training information35
 Sidetone level25
 Squelch test function.....20
 Standby frequency selection5

T

Time-Out-Timer27
 Transceiver installation28
 Transceiver removal.....28
 Transferring memory contents12
 Transmitting6
 Transmitting microphone selection25

U

USER-1 setting26
 USER-2 setting26

W

Weather memory channel9, 17
 Weather memory channel scan21



Your Icom radio generates RF electromagnetic energy during transmit mode. This radio is designed for and classified as “Occupational Use Only”, meaning it must be used only during the course of employment by individuals aware of the hazards, and the ways to minimize such hazards. This radio is **NOT** intended for use by the “General Population” in an uncontrolled environment.

- For compliance with FCC and Industry Canada RF Exposure Requirements, the transmitter antenna installation shall comply with the following two conditions:
 1. The transmitter antenna gain shall not exceed 0 dBi.
 2. The antenna is required to be located outside of a vehicle and kept at a distance of 36 centimeters or more between the transmitting antenna of this device and any persons during operation. For a small vehicle, the antenna as worst case, the antenna shall be located on the roof top at any place on the centre line along the vehicle in order to achieve 36 centimeters separation distance. In order to ensure this distance is met, the installation of the antenna must be mounted at least 36 centimeters away from the nearest edge of the vehicle in order to protect against exposure to bystanders.



To ensure that your exposure to RF electromagnetic energy is within the FCC allowable limits for occupational use, always adhere to the following guidelines:

- **DO NOT** operate the radio without a proper antenna attached, as this may damage the radio and may also cause you to exceed FCC RF exposure limits. A proper antenna is the antenna supplied with this radio by the manufacturer or an antenna specifically authorized by the manufacturer for use with this radio.
- **DO NOT** transmit for more than 50% of total radio use time (“50% duty cycle”). Transmitting more than 50% of the time can cause FCC RF exposure compliance requirements to be exceeded. The radio is transmitting when the “TX indicator” appears. You can cause the radio to transmit by pressing the “PTT” switch.

Electromagnetic Interference/Compatibility

During transmissions, your Icom radio generates RF energy that can possibly cause interference with other devices or systems. To avoid such interference, turn off the radio in areas where signs are posted to do so. **DO NOT** operate the transmitter in areas that are sensitive to electromagnetic radiation such as hospitals, aircraft, and blasting sites.

Count on us! www.bi-comm.co.za

A-6602H-1EX-②
Printed in Japan
© 2007 Icom Inc.

Printed on recycled paper with soy ink.

Icom Inc.

1-1-32 Kamiminami, Hirano-ku, Osaka 547-0003, Japan